

## Product Summary

Models consists of different sizes of sinks, with cupboard in sliding doors, hinged doors with panels. Sizes from 1500, 1800, 2100 mm in length, and with two bowls and drain board.

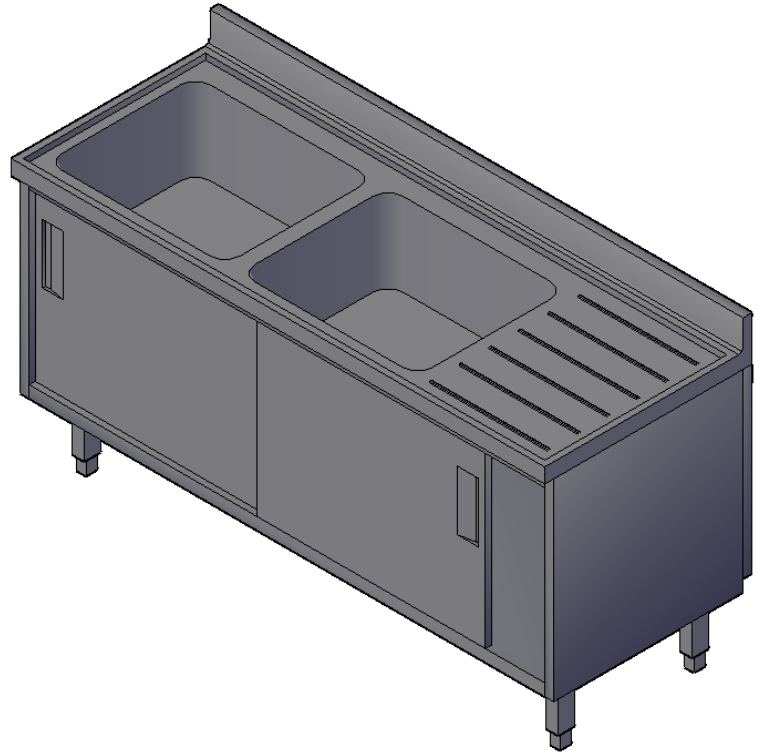











Sink cupboard units are ideal for washing, cleaning and storage.



## DOUBLE BOWL SINK ON CUPBOARD

**1500/2100mm**

### Technical Custom Fabrication Product Description

-  Made entirely from stainless steel with argon welded construction for maximum strength.
-  Inner welded frame in stainless steel to guarantee superior strength and durability. Connection from panels to inner frame.
-  The 40 mm high worktop in 304 AISI stainless steel, incorporates a layer of sound deadening and water-proof material, has upturned edges to protect the kitchen worker.
-  Side and base panels in 304 AISI stainless steel.
-  Splash back with 100 mm high, designed to be used against a wall.
-  Sink bowl in 304 AISI stainless steel.
-  The sound-deadened sturdy sliding doors in 304 AISI stainless steel are on tracks located flush to the front of the frame.
-  Easy access to the cupboard interior on all lengths.
-  All panel edges are upturned to guarantee the safety of the kitchen worker.
-  100 to 150 mm high AISI 304 stainless steel feet, 40mm in diameter for round legs and 40x40mm for square legs adjustable as required on site.
-  All models comply with standards as far as hygiene and cleanability are concerned.
-  Other option can be obtained as per requirements.

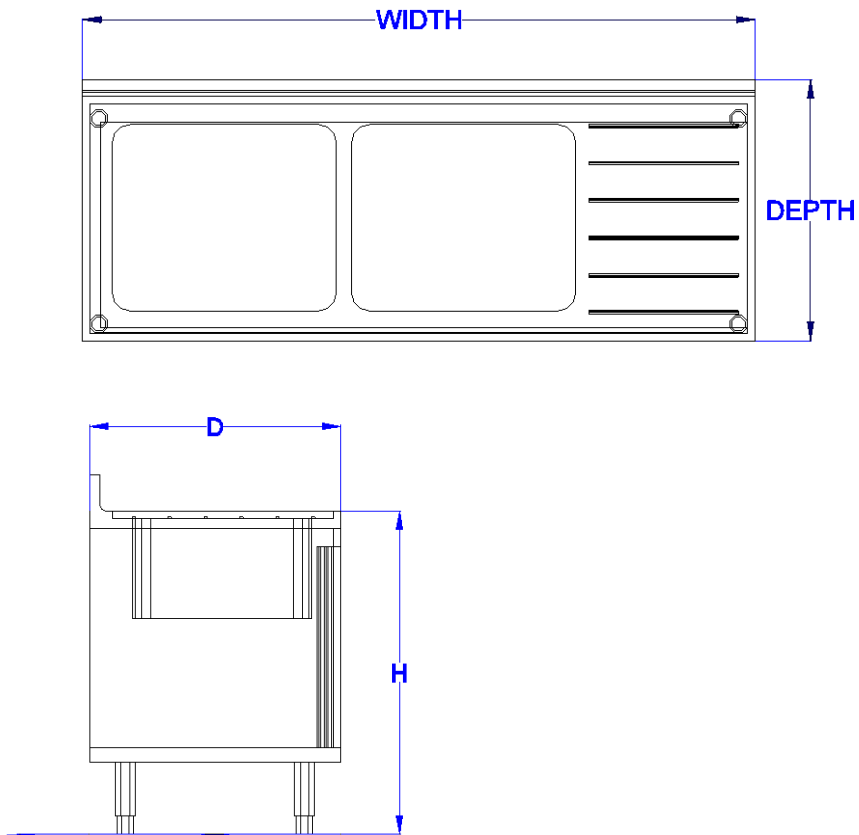

**Notes: Hinged Doors are also available in different sizes as required.**

## TECHNICAL DATA

WIDTH	DEPTH	HEIGHT	REAR UPSTAND (AVAILABLE IN ANY SIZE)	REMARKS
1500	700	850	100	Sliding or Hinged doors
1800	700	850	100	Sliding or Hinged doors
2100	700	850	100	Sliding or Hinged doors

*All measurements are in mm*



### The Technical Company

P.O. Box 5090 Safat, 13051 Kuwait -Tel: +965-1800771 Fax: +965-24848310

E-mail: info@alqudaibi.com – Website: www.alqudaibi.com

*A Subsidiary of QDB Holding*



*The Company reserves the right to alter any technical specifications without prior notice.*