

Product Summary

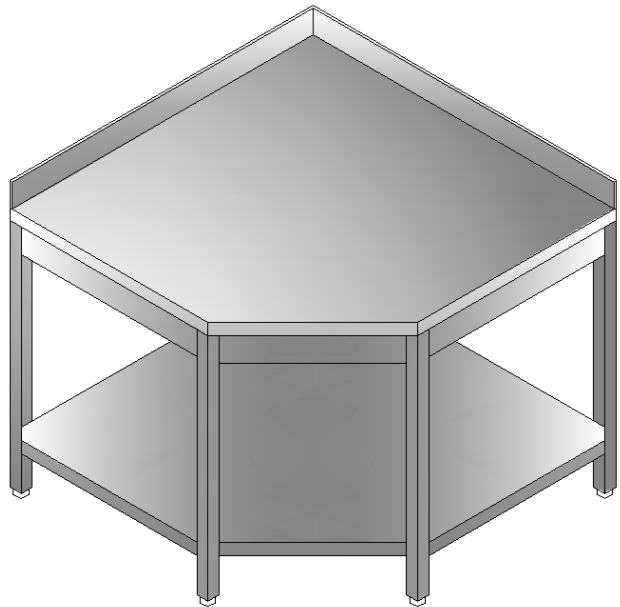









This Model composed of 2 size only at 1100x1100 mm for 700mm Series and 1000x1000mm for 600 Series, with lower shelf and with two splash backs. Inner space useful to store crockery and other kitchen utensil.



WORKTOP CORNER TABLE WITH UPSTAND

1000/1100mm

Technical Custom Fabrication Product Description

-  Made entirely from stainless steel with argon welded construction for maximum strength.
-  Inner welded frame in stainless steel to guarantee superior strength and stability.
-  Splashback with 100 mm high, designed to be used against a wall.
-  The 40 mm high worktop in 304 AISI stainless steel, and incorporates a layer of sound deadening water-proof material, has upturned edges to protect the kitchen worker.
-  Side and base panel in 304 AISI stainless steel.
-  The sound-deadened sturdy sliding doors and hinged doors in 304 AISI stainless steel.
-  Easy access to the cupboard interior on all lengths.
-  All panel edges are upturned to guarantee the safety of the kitchen worker.
-  100 to 150 mm high AISI 304 stainless steel feet, 40mm in diameter for round legs and 40x40mm for square legs adjustable as required on site mm.
-  All models comply with standards as far as hygiene and cleanability are concerned.
-  Other option can be obtained as per requirements.

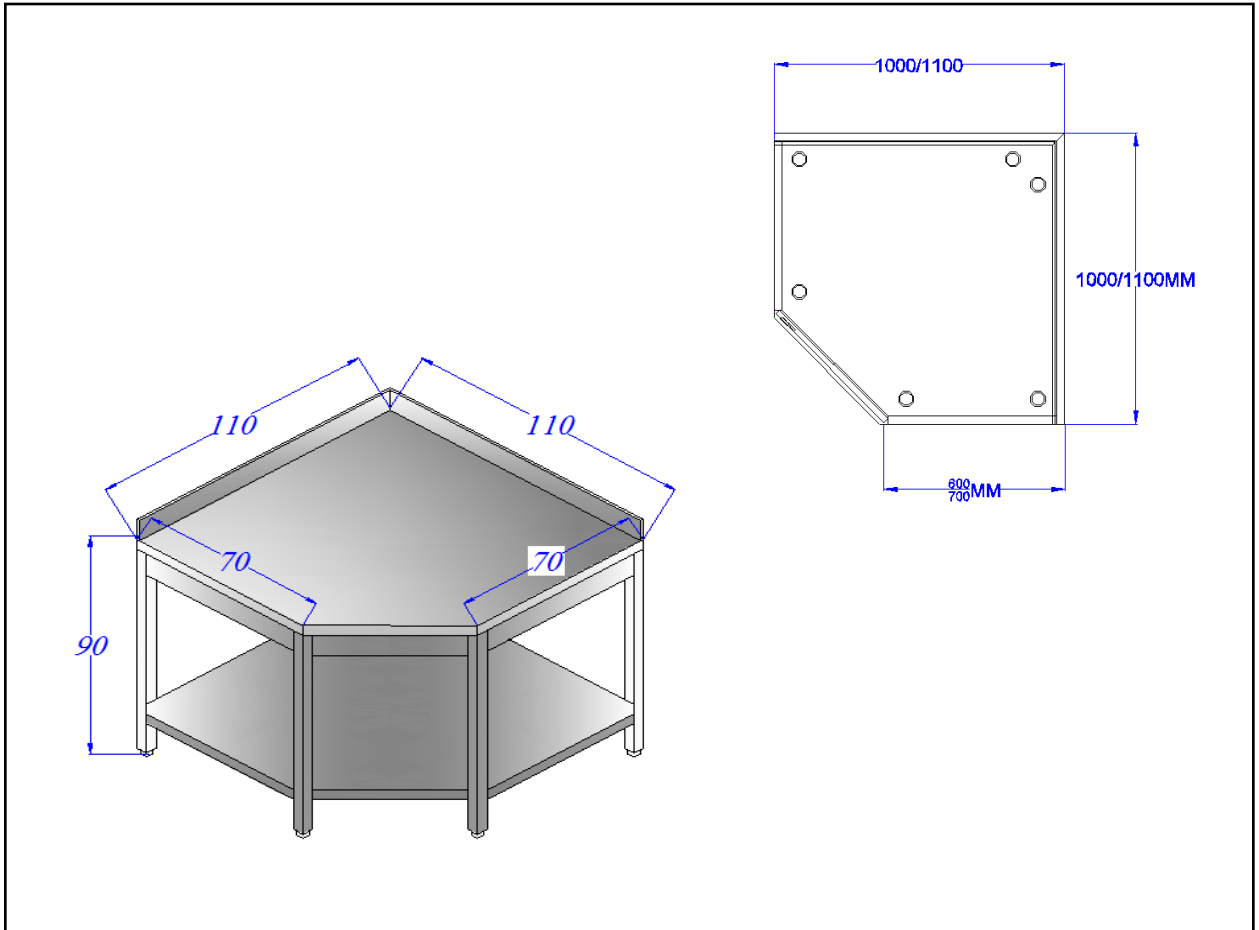

TECHNICAL DATA			
WIDTH	DEPTH	HEIGHT	REAR UPSTAND
1000	600	850	100
1100	700	850	100
<i>All measurements are in mm</i>			



The Technical Company

P.O. Box 5090 Safat, 13051 Kuwait -Tel: +965-1800771 Fax: +965-24848310
 E-mail: info@alqudaibi.com – Website: www.alqudaibi.com

A Subsidiary of QDB Holding

